

**Class XII Session 2023-24**  
**Subject - Physics**  
**Sample Question Paper - 1**

Time Allowed: 3 hours

Maximum Marks: 70

**General Instructions:**

1. There are 33 questions in all. All questions are compulsory.
2. This question paper has five sections: Section A, Section B, Section C, Section D and Section E.
3. All the sections are compulsory.
4. **Section A** contains sixteen questions, twelve MCQ and four Assertion Reasoning based of 1 mark each, **Section B** contains five questions of two marks each, **Section C** contains seven questions of three marks each, **Section D** contains two case study based questions of four marks each and **Section E** contains three long answer questions of five marks each.
5. There is no overall choice. However, an internal choice has been provided in one question in Section B, one question in Section C, one question in each CBQ in Section D and all three questions in Section E. You have to attempt only one of the choices in such questions.
6. Use of calculators is not allowed.

**Section A**

1. Pure silicon at 300 K has equal electron ( $n_e$ ) and hole ( $n_h$ ) concentrations of  $1.5 \times 10^{16} \text{ m}^{-3}$ . Doping by indium [1]  
increases  $n_h$  to  $4.5 \times 10^{22} \text{ m}^{-3}$ . The  $n_e$  in the doped silicon is  
a)  $3 \times 10^{19} \text{ m}^{-3}$  b)  $9 \times 10^{-5} \text{ m}^{-3}$   
c)  $2.25 \times 10^{11} \text{ m}^{-3}$  d)  $5 \times 10^9 \text{ m}^{-3}$
2. The dimension of electrical resistance is: [1]  
a)  $[\text{ML}^2\text{T}^{-3}\text{A}^1]$  b)  $[\text{ML}^2\text{T}^{-3}\text{A}^{-2}]$   
c)  $[\text{ML}^3\text{T}^{-3}\text{A}^{-2}]$  d)  $[\text{ML}^2\text{T}^{-3}\text{A}^{-1}]$
3. How will the image formed by a convex lens be affected if the central portion of the lens is wrapped in a black [1]  
paper?  
a) No image is formed by the remaining portion of the lens b) Full image will be formed but will be less bright  
c) Two images will be formed d) Central portion of the image will be absent
4. A bar magnet of length 3 cm has points A and B along its axis at distances of 24 cm and 48 cm on the opposite [1]  
sides. Ratio of magnetic fields at these points will be



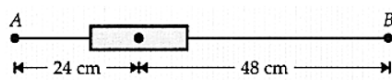

a)  $\frac{1}{2\sqrt{2}}$

b) 4

c) 3

d) 8

5. In which of the states shown in the figure, is potential energy of an electric dipole maximum? [1]

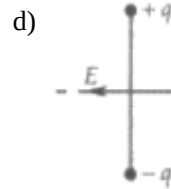
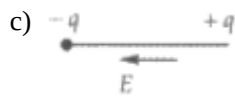
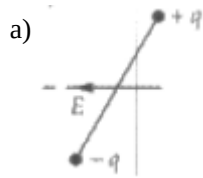

6. An electron having energy 10 eV is circulating in path of radius 0.105 m having magnetic field of  $10^{-4}$ T. The speed of the electron will be: [1]

a)  $1.9 \times 10^6 \text{ m/s}$

b)  $3.8 \times 10^{12} \text{ m/s}$

c)  $1.9 \times 10^{12} \text{ m/s}$

d)  $3.8 \times 10^6 \text{ m/s}$

7. Two coils are placed closed to each other. The mutual inductance of the pair of coils depends upon: [1]

a) the currents in the two coils

b) the rates at which currents are changing in the two coils

c) relative position and orientation of the two coils

d) the material of the wires of the coils

8. A closely wound solenoid of 800 turns and area of cross section  $2.5 \times 10^{-4} \text{ m}^2$  carries a current of 3.0 A. What is its associated magnetic moment? [1]

a) 0.4 J/T

b) 0.8 J/T

c) 0.6 J/T

d) 0.5 J/T

9. In Young's double-slit experiment, the intensity of light at a point on the screen where the path difference is  $\lambda$  is k ( $\lambda$  being the wavelength of light used). The intensity at a point where the path difference is  $\frac{\lambda}{4}$ , will be [1]

a) k

b)  $\frac{k}{4}$

c)  $\frac{k}{2}$

d) zero

10. An uncharged sphere of metal is placed inside a charged parallel plate capacitor. The lines of force look like [1]

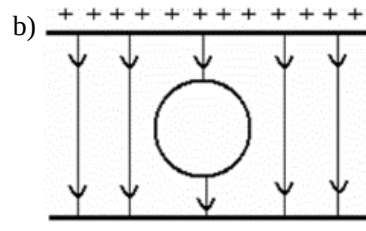
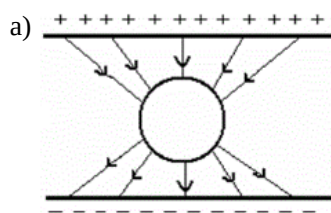

c)

d)

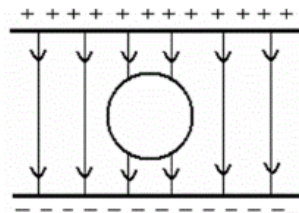
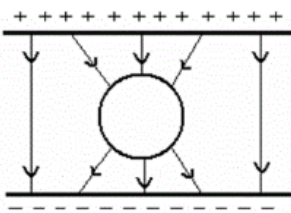

11. Assume that each diode shown in the figure has a forward bias resistance of  $50\Omega$  and an infinite reverse bias resistance. The current through the  $150\Omega$  resistance is [1]

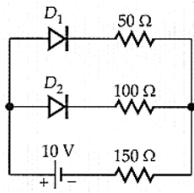

- a) 0.04 A                                  b) zero  
 c) 0.05 A                                  d) 0.66 A
12. A lamp and a screen are set up 100 cm apart and a convex lens is placed between them. The two positions of the lens forming real images on the screen are 40 cm apart. What is the focal length of the lens? [1]
- a) 15 cm                                      b) 21 cm  
 c) 18 cm                                      d) 12 cm

13. **Assertion (A):** The process of photoelectric emission is different to that of thermionic emission. [1]  
**Reason (R):** The process of thermionic emission is temperature-dependent but photoelectric emission is independent of temperature.
- a) Both A and R are true and R is the correct explanation of A.                                  b) Both A and R are true but R is not the correct explanation of A.  
 c) A is true but R is false.                                  d) A is false but R is true.

14. **Assertion:** When a capacitor is filled completely with a metallic slab its capacity becomes very large. [1]  
**Reason:** Dielectric constant for metal is zero.
- a) Both A and R are true and R is the correct explanation of A                                  b) Both A and R are true but R is NOT the correct explanation of A  
 c) A is true but R is false                                  d) A is false and R is also false

15. **Assertion (A):** Young’s double slit experiment can be performed using a source of white light. [1]  
**Reason (R):** The wavelength of red light is less than the wavelength of other colours in white light.
- a) Both A and R are true and R is the correct explanation of A                                  b) Both A and R are true but R is NOT the correct explanation of A  
 c) A is true but R is false                                  d) A is false and R is also false

16. **Assertion (A):** If the frequency of the applied AC is doubled, then the power factor of a series R-L circuit decreases. [1]  
**Reason (R):** Power factor of series R-L circuit is given by  $\cos \phi = \frac{2R}{R^2 + \omega^2 L^2}$ .

- a) Both A and R are true and R is the correct explanation of A.                                  b) Both A and R are true but R is not the correct explanation of A.  
 c) A is true but R is false.                                  d) A is false but R is true.

### Section B

17. Identify the electromagnetic waves whose wavelengths lie in the range. [2]
- $10^{-11} \text{ m} < \lambda < 10^{-14} \text{ m}$
  - $10^{-4} \text{ m} < \lambda < 10^{-6} \text{ m}$
- Write one use of each.
18. A muon is a particle that has the same charge as an electron but is 200 times heavier than it. If we had an atom in which the muon revolves around a proton instead of an electron, what would be the magnetic moment of the muon in the ground state of such an atom? [2]
19. Define barrier potential. Why does the thickness of the depletion layer in a p-n junction diode vary with increase in reverse bias? [2]
20. Consider two different hydrogen atoms. The electron in each atom is in an excited state possible for the electrons to have different energies, but the same orbital angular momentum according to the Bohr model? [2]
21. A coil of  $N$  turns and radius  $R$  carries a current  $T$ . It is unwound and rewound to make a square coil of side  $a$  having the same number of turns ( $N$ ). Keeping the current  $I$  same, find the ratio of the magnetic moments of the square coil and the circular coil. [2]

OR

Is the force between two parallel current-carrying wires affected by the nature of the dielectric medium between them?

### Section C

22. AB, BC, CD and DA are resistors of  $1, 1, 2$  and  $2 \Omega$  respectively connected in series. Between A and C is a  $1 \text{ V}$  cell of resistance  $2 \Omega$ , A being positive. Between B and D is a  $2 \text{ V}$  cell of  $1 \Omega$  resistance, B being positive. Find the current in each branch of the circuit. [3]
23. Define the terms **potential barrier** and **depletion region** for a p-n junction diode. State how the thickness of the depletion region will change when p-n junction diode is [3]
- forward biased and
  - reverse biased
24. Draw the graph showing the variation of photoelectric current with anode potential of a photocell for [3]
- the same frequencies but different intensities  $I_3 > I_2 > I_1$  of incident radiation, and
  - the same intensity but different frequencies  $\nu_1 > \nu_2 > \nu_3$  of incident radiation.
25. Plot a graph showing the variation of binding energy per nucleon as a function of mass number. Which property of nuclear force explains the approximate constancy of binding energy in the range  $30 < A < 170$ ? [3]
- How does one explain the release of energy in both processes of nuclear fission and fusion from the graph?
26. It is found experimentally that  $13.6 \text{ eV}$  energy is required to separate a hydrogen atom into a proton and an electron. Compute the orbital radius and the velocity of the electron in a hydrogen atom. [3]
27. Explain by drawing a suitable diagram that the interference pattern in a double-slit is actually a superposition of single-slit diffraction from each slit. [3]
- Write two basic features that distinguish the interference pattern from those seen in a coherently illuminated single slit.
28. A rectangular loop of sides  $8 \text{ cm}$  and  $2 \text{ cm}$  with a small cut is moving out of a region of uniform magnetic field of magnitude  $0.3 \text{ tesla}$  directed normal to the loop. What is the voltage developed across the cut if velocity of loop is  $1 \text{ cm.s}^{-1}$  in a direction normal to the (i) longer side (ii) shorter side of the loop? For how long does the [3]



induced voltage last in each case?

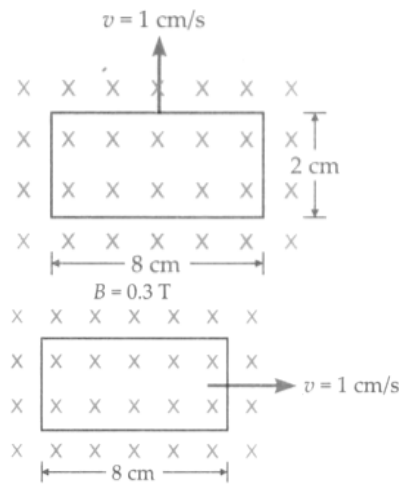

OR

The current flowing through an inductor of self-inductance  $L$  is continuously increasing. Plot a graph showing the variation of:

- Magnetic flux versus the current
- Induced emf versus  $di/dt$
- Magnetic potential energy stored versus the current.

#### Section D

29. Read the text carefully and answer the questions:

[4]

Maxwell showed that the speed of an electromagnetic wave depends on the permeability and permittivity of the medium through which it travels. The speed of an electromagnetic wave in free space is given by  $c = \frac{1}{\sqrt{\mu_0 \epsilon_0}}$ . The fact led Maxwell to predict that light is an electromagnetic wave. The emergence of the speed of light from purely electromagnetic considerations is the crowning achievement of Maxwell's electromagnetic theory. The speed of an electromagnetic wave in any medium of permeability  $\mu$  and permittivity  $\epsilon$  will be  $\frac{c}{\sqrt{K\mu_r}}$  where  $K$  is the dielectric constant of the medium and  $\mu_r$  is the relative permeability.

(i) The dimensions of  $\frac{1}{2}\epsilon_0 E^2$  ( $\epsilon_0$  : permittivity of free space;  $E$  = electric field) is

- |                 |                    |
|-----------------|--------------------|
| a) $MLT^{-1}$   | b) $ML^{-1}T^{-2}$ |
| c) $ML^2T^{-2}$ | d) $ML^2T^{-1}$    |

(ii) Let  $[\epsilon_0]$  denote the dimensional formula of the permittivity of the vacuum. If  $M$  = mass,  $L$  = length,  $T$  = time and  $A$  = electric current, then

- |  |                                      |
|--|--------------------------------------|
| a) $[\epsilon_0] = ML^2T^{-1}$         | b) $[\epsilon_0] = MLT^{-2}A^{-2}$   |
| c) $[\epsilon_0] = M^{-1}L^{-3}T^4A^2$ | d) $[\epsilon_0] = M^{-1}L^{-3}T^2A$ |

(iii) An electromagnetic wave of frequency 3 MHz passes from vacuum into a dielectric medium with permittivity  $\epsilon = 4$ . Then

- |  |   |
|--|---|
| a) wavelength is halved and the frequency remains unchanged. | b) wavelength and frequency both remain unchanged       |
| c) wavelength is doubled and the frequency remains unchanged | d) wavelength is doubled and the frequency becomes half |

OR



The electromagnetic waves travel with

- a) the speed of light  $c = 3 \times 10^8 \text{ m s}^{-1}$  in fluid medium.      b) the speed of light  $c = 3 \times 10 \text{ m s}^{-1}$  in solid medium
- c) the speed of light  $c = 3 \times 10^8 \text{ m s}^{-1}$  in free space      d) the same speed in all media

(iv) Which of the following are not electromagnetic waves?

cosmic rays,  $\gamma$ -rays,  $\beta$ -rays, X-rays

- a)  $\beta$ -rays      b) X-rays
- c)  $\gamma$ -rays      d) cosmic rays

30. **Read the text carefully and answer the questions:**

[4]

A charge is a property associated with the matter due to which it experiences and produces an electric and magnetic field. Charges are scalar in nature and they add up like real numbers. Also, the total charge of an isolated system is always conserved. When the objects rub against each other charges acquired by them must be equal and opposite.

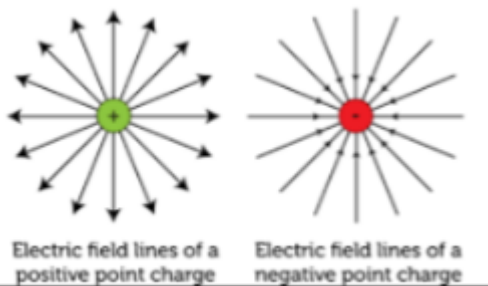

(i) The cause of charging is:

- a) none of these      b) the actual transfer of protons
- c) the actual transfer of electrons      d) the actual transfer of neutrons

(ii) Pick the correct statement.

- i. The glass rod gives protons to silk when they are rubbed against each other.
- ii. The glass rod gives electrons to silk when they are rubbed against each other.
- iii. The glass rod gains protons from silk when they are rubbed against each other.
- iv. The glass rod gains electrons when they are rubbed against each other.

- a) Option (i)      b) Option (iv)
- c) Option (iii)      d) Option (ii)

(iii) If two electrons are each  $1.5 \times 10^{-10} \text{ m}$  from a proton, as shown in Figure, magnitude of the net electric force they will exert on the proton is

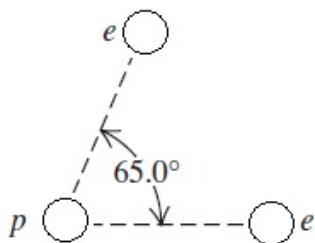

- a)  $1.97 \times 10^{-8} \text{ N}$       b)  $3.83 \times 10^{-8} \text{ N}$

c)  $4.63 \times 10^{-8} \text{ N}$

d)  $2.73 \times 10^{-8} \text{ N}$

(iv) A charge is a property associated with the matter due to which it produces and experiences:

a) electric effects only

b) magnetic effects only

c) both electric and magnetic effects

d) none of these

**OR**

The cause of quantization of electric charges is:

a) transfer of an integral number of electrons

b) transfer of an integral number of neutrons

c) transfer of an integral number of protons

d) none of these

**Section E**

31. a. Draw the ray diagram showing the refraction of light through a glass prism and hence obtain the relation between the refractive index  $\mu$  of the prism, angle of prism and angle of minimum deviation. [5]  
 b. Determine the value of the angle of incidence for a ray of light travelling from a medium of refractive index  $\mu_1 = \sqrt{2}$  into the medium of refractive index  $\mu_2 = 1$ , so that it just grazes along the surface of separation.

**OR**

- i. In a double slit experiment using the light of wavelength 600 nm, the angular width of the fringe formed on a distant screen is  $0.1^\circ$ . Find the spacing between the two slits.

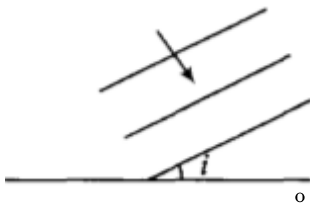

- ii. Light of wavelength  $500 \text{ \AA}$  propagating in air gets partly reflected from the surface of water. How will the wavelengths and frequencies of the reflected and refracted light be affected?

32. i. A parallel plate capacitor is charged by a battery to a potential. The battery is disconnected and a dielectric slab is inserted to completely fill the space between the plates. How will [5]  
 a. its capacitance  
 b. electric field between the plates and  
 c. energy stored in the capacitor be affected?

Justify your answer giving necessary mathematical expressions for each case.

- ii. a. Draw the electric field lines due to a conducting sphere.  
 b. Draw the electric field lines due to a dipole.

**OR**

From the network shown in Fig. find the value of the capacitance C if the equivalent capacitance between points A and B is to be  $1 \mu\text{F}$ . All the capacitances are in  $\mu\text{F}$ .

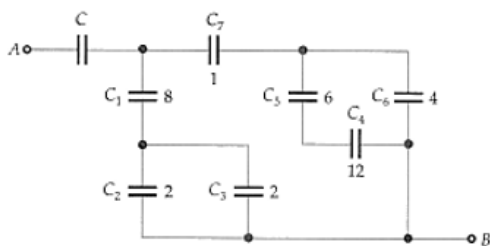

33. An ac voltage  $V = V_0 \sin \omega t$  is applied to a pure inductor  $L$ . Obtain an expression for the current in the circuit. [5]

Prove that the average power supplied to an inductor over one complete cycle is zero.

OR

- i. Describe, with the help of a suitable diagram, the working principle of a step-up transformer. Obtain the relation between input and output voltages in terms of the number of turns of primary and secondary windings and the currents in the input and output circuits.
- ii. Given the input current 15 A and the input voltage of 100 V for a step-up transformer having 90% efficiency, find the output power and the voltage in the secondary if the output current is 3 A.





# Solution

## Section A

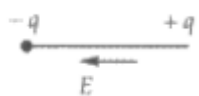
- (d)  $5 \times 10^9 \text{ m}^{-3}$   
**Explanation:**  $n_e = \frac{n_i^2}{n_h} = \frac{(1.5 \times 10^{16})^2}{4.5 \times 10^{22}} \text{ m}^{-3} = 5 \times 10^9 \text{ m}^{-3}$
- (b)  $[\text{ML}^2\text{T}^{-3}\text{A}^{-2}]$   
**Explanation:** Power =  $i^2R \Rightarrow \frac{\text{Work done}}{\text{Time}} = \frac{\text{Force} \times \text{Dis tance}}{\text{Time}}$   
 $\Rightarrow [R] = \left[ \frac{\text{MLT}^{-2}\text{L}}{\text{T}} \right] \left[ \left( \frac{1}{\text{A}^2} \right) \right]$   
 $\Rightarrow [R] = \text{ML}^2\text{T}^{-3}\text{A}^{-2}$
- (b) Full image will be formed but will be less bright  
**Explanation:** Image will be formed at the same position and same height but intensity of image formed will be less hence its brightness will be less as less number of light rays will form the image. Light rays from the covered portion will not contribute to image formation.
- (d) 8  
**Explanation:** For a short magnet,  
 $B_{\text{axial}} \propto \frac{1}{d^3}$   
 $\therefore \frac{B_A}{B_B} = \left( \frac{48}{24} \right)^3 = 8$
- (c)   
**Explanation:** P.E. of a dipole is maximum when  $\vec{p}$  is antiparallel to  $\vec{E}$ .  
 $U = -pE \cos 180^\circ = +pE = \text{maximum +ve value.}$
- (a)  $1.9 \times 10^6 \text{ m/s}$   
**Explanation:**  $Bqv = \frac{mv^2}{r}$   
 $Bqv = \frac{2E}{r}$   
 $v = \frac{2E}{rBq} = \frac{2 \times 10 \times 1.6 \times 10^{-19}}{0.105 \times 10^{-4} \times 1.6 \times 10^{-19}}$   
 $= 1.9 \times 10^6 \text{ m/s}$
- (c) relative position and orientation of the two coils  
**Explanation:** The mutual inductance of a pair of coils depends upon the relative position and orientation of the two coils.
- (c) 0.6 J/T  
**Explanation:**  $m = NIA = 800 \times 3 \times 2.5 \times 10^{-4} = 0.6 \text{ J/T}$
- (c)  $\frac{k}{2}$   
**Explanation:** Path difference  $\lambda$  implies a maximum, so  $I_{\text{max}} = k$   
 $I = I_{\text{max}} \cos^2 \frac{\phi}{2} = k \cos^2 \left( \frac{1}{2} \cdot \frac{2\pi}{\lambda} \cdot \frac{\lambda}{4} \right)$   
 $= k \cos^2 \frac{\pi}{4} = k \left( \frac{1}{\sqrt{2}} \right)^2 = \frac{k}{2}$

10.

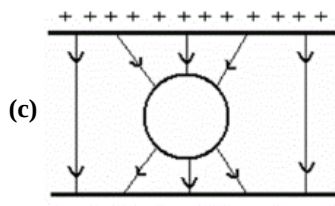

**Explanation:** Between the plates of capacitor, electric field is uniform. When an uncharged conducting sphere is placed in this region, free charges move within the conductor, polarizing it, until the electric field lines are perpendicular to the surface. The field lines end on excess negative charge on one section of the surface and begin again on excess positive charge on the opposite side. No electric field exists inside the conductor, since free charges in the conductor would continue moving in response to any field until it was neutralized.

11. (a) 0.04 A

**Explanation:**

Diode  $D_1$  is forward biased and offers  $50 \Omega$  resistance. Diode  $D_2$  is reverse biased and offers infinite resistance. The equivalent circuit is

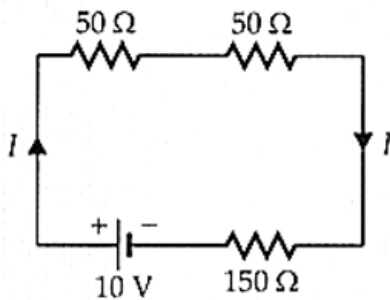

Current through the  $150\Omega$  resistance,

$$I = \frac{10}{50+50+150} = \frac{10}{250} = 0.04 \text{ A}$$

12.

(b) 21 cm

**Explanation:**

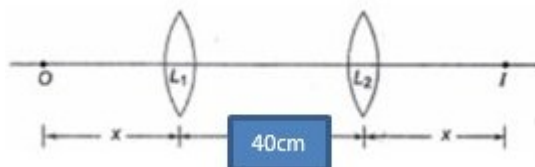

Distance between two positions of lens,  $L_1L_2 = 40 \text{ cm}$  and  $OI = 100 \text{ cm}$

Let distance of object from  $L_1 = x$ , therefore  $u = -x$ , hence  $x + 40 + x = 100$  or  $x = 30 \text{ cm}$

For  $L_1$  we have,  $u = -30 \text{ cm}$  and  $v = 70 \text{ cm}$

Putting values in lens formula,

$$\frac{1}{f} = \frac{1}{v} - \frac{1}{u}$$

$$\frac{1}{f} = \frac{1}{70} + \frac{1}{30}$$

On solving we get,  $f = +21 \text{ cm}$

13. (a) Both A and R are true and R is the correct explanation of A.

**Explanation:** In photoelectric emission, the free-electrons in the metal absorb the photons, acquire energy and come out of metal. In thermionic emission, electrons acquire energy by heat. Hence, this effect is temperature-dependent.

14.

(d) A is false and R is also false

**Explanation:** A is false and R is also false

15.

(d) A is false and R is also false

**Explanation:** A is false and R is also false

16.

(c) A is true but R is false.

**Explanation:**  $\cos \phi = \frac{R}{Z} = \frac{R}{\sqrt{R^2 + \omega^2 L^2}}$

When  $\omega$  is doubled, power factor ( $\cos \phi$ ) decreases.

So, A is true but R is false.

### Section B

17. i. Wavelength range of  $10^{-11} \text{ m} < \lambda < 10^{-14} \text{ m}$  shows the presence of both X-rays and Gamma rays as Gamma-rays have wavelength ranges from  $10^{-14} \text{ m} - 10^{-11} \text{ m}$  while the X-rays wavelength ranges from  $10^{-12} \text{ m} - 10^{-8} \text{ m}$ .

Uses: (any one)

a. Gamma-radiations are used in medical treatment and for checking flaws in metal castings and for detection by photographic plates or radiation detectors.

b. X-rays are used in medicine and dentistry and may be detected using photographic film.

ii. The wavelength range of  $10^4 \text{ m} < \lambda < 10^6 \text{ m}$  shows the presence of Infrared, Visible and Microwave.

Uses : (any one)

a. Infrared radiation is useful for haze photography and is used by Earth resource satellites to detect healthy crops. It can be used to study human and animal body heat patterns.

b. Visible light affects a photographic film, stimulates the retina in the eye and causes photosynthesis in plants.

c. Microwaves are used in radar, telemetry and electron spin resonance studies and in microwave ovens.

18. Magnetic moment of an electron in ground state,

$$\mu_l (\text{electron}) = \frac{eh}{4\pi m_e}$$

As mass of a muon is 200 times the mass of an electron, i.e., its magnetic moment in the ground state is

$$\begin{aligned} \mu_l (\text{muon}) &= \frac{eh}{4\pi \times 200m_e} \\ &= \frac{1.6 \times 10^{-19} \times 6.6 \times 10^{-34}}{4\pi \times 200 \times 9.1 \times 10^{-31}} \\ &= 4.63 \times 10^{-26} \text{ Am}^2 \end{aligned}$$

19. Barrier potential is the potential difference required by the electrons in the PN junction diode to pass the electric field across the semiconductors.

During reverse biased conditions the p junction of the diode is connected to the negative of the battery and N junction to the positive of the battery. Thus the holes of the P side are pulled away from junction and electrons from N side leave the charged ions and thus the thickness of the depletion layer increases.

20. No, because according to Bohr model,  $E_n = -\frac{13.6}{n^2}$  and electrons having different energies belong to different levels having different values of n. So, their angular momenta will be different, as  $L = mvr = \frac{nh}{2\pi}$

21.  $A_1 = \pi R^2$

for a circular loop  $m_1 = NIA_1$

$A_2 = a^2$  [Square coil]

for a square  $m_2 = NIA_2$

$$\frac{m_1}{m_2} = \frac{NIA_1}{NIA_2}$$

$$= \frac{\pi R^2}{a^2}$$

$$\frac{m_1}{m_2} = \frac{22}{7} \left( \frac{R}{a} \right)^2$$

OR

No. This interaction is between the magnetic fields produced by the two wires which does not depend on the nature of the dielectric medium.

### Section C

22. The circuit arrangement and current distribution is shown in Figure.

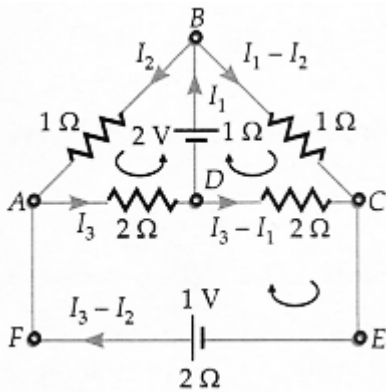

Applying Kirchoff's second law to loops BADB, BCDB and ADCEFA, we get

$$1I_2 + 2I_3 + 1I_1 = 2$$

$$\text{or } I_1 + I_2 + 2I_3 = 2 \dots(i)$$

$$\text{or } 1(I_1 - I_2) - 2(I_3 - I_1) + I_1 = 2$$

$$\text{or } 4I_1 - I_2 - 2I_3 = 2 \dots(ii)$$

$$\text{and } 2I_3 + 2(I_3 - I_1) + 2(I_3 - I_2) = 1$$

$$\text{or } -2I_1 - 2I_2 + 6I_3 = 1 \dots(iii)$$

Solving equations (i), (ii) and (iii), we get

$$I_1 = 0.8 \text{ A, } I_2 = 0.2 \text{ A and } I_3 = 0.5 \text{ A}$$

Currents in different branches are

$$I_{AB} = I_2 = 0.2 \text{ A;}$$

$$I_{BC} = I_1 - I_2 = 0.6 \text{ A;}$$

$$I_{CD} = I_1 - I_3 = 0.3 \text{ A;}$$

$$I_{AD} = I_3 = 0.5 \text{ A;}$$

$$I_{EF} = I_3 - I_2 = 0.3 \text{ A}$$

23. **Potential barrier:** The potential barrier is the fictitious battery, which seems to be connected across the p-n junction with its positive terminal in the n-region and the negative terminal in the p-region.

**Depletion region:** The region around the junction, which is devoid of any mobile charge carriers, is called the depletion layer or region.

i. The forward-bias connections of a p-n junction are as shown in Fig.

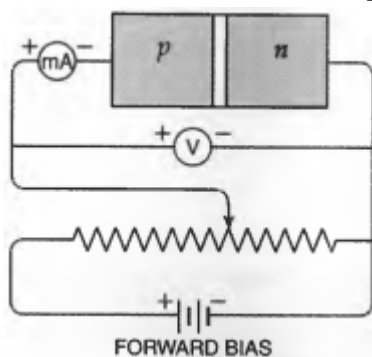

When the p-n junction is forward biased, the depletion layer becomes thin. It is because, the polarity of the external d.c. source opposes the fictitious battery developed across the junction. As a result, the potential drop across the junction decreases making the depletion layer thin. It leads to the low resistance of the junction diode during forward bias.

ii. The reverse-bias connections of a p-n junction are as shown in Fig.

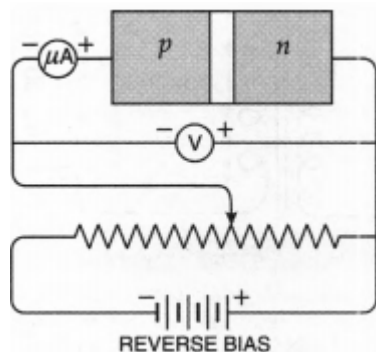

When the p-n junction is reverse biased, the depletion layer becomes thick. It is because, the external d.c. source aids the fictitious battery. It results in the increase of potential drop across the junction and the depletion layer appears thick. Because of the increased thickness of the depletion layer, the p-n junction offers high resistance during reverse bias.

24. I) The variation of photoelectric current with potential at different intensities but at same frequency is as shown below

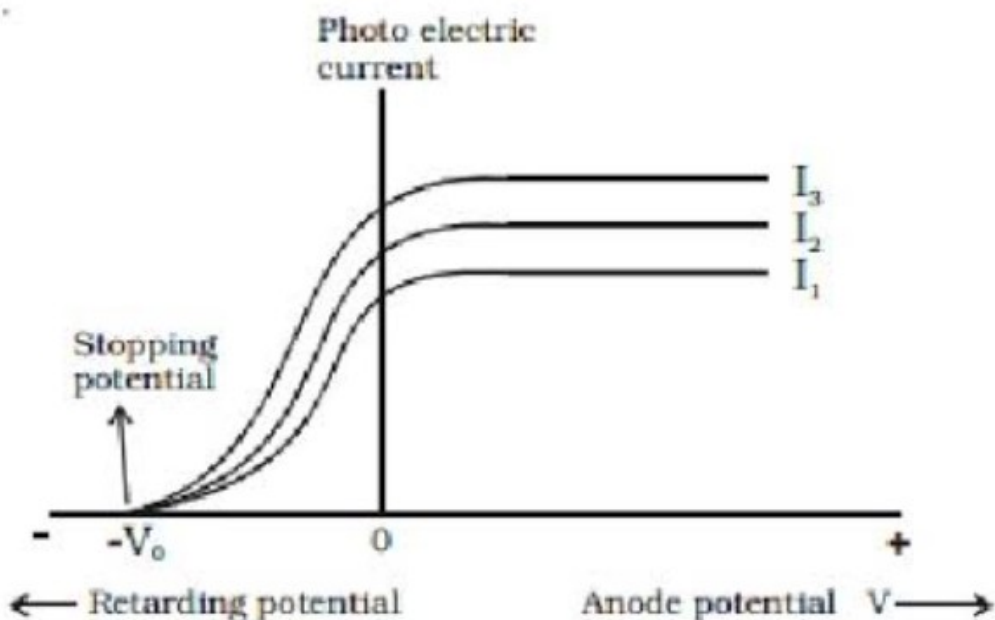

*Variation of photo electric current with potential difference.*

ii) The variation of photoelectric current with potential at different frequencies but at same intensity is given as

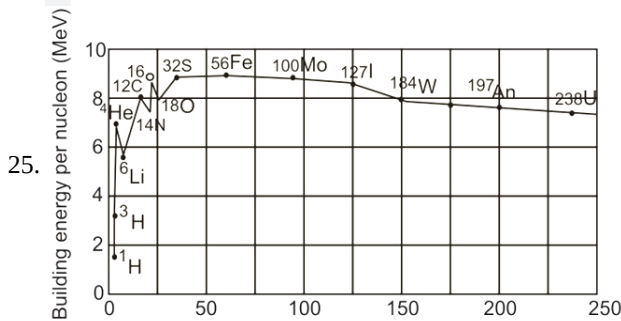
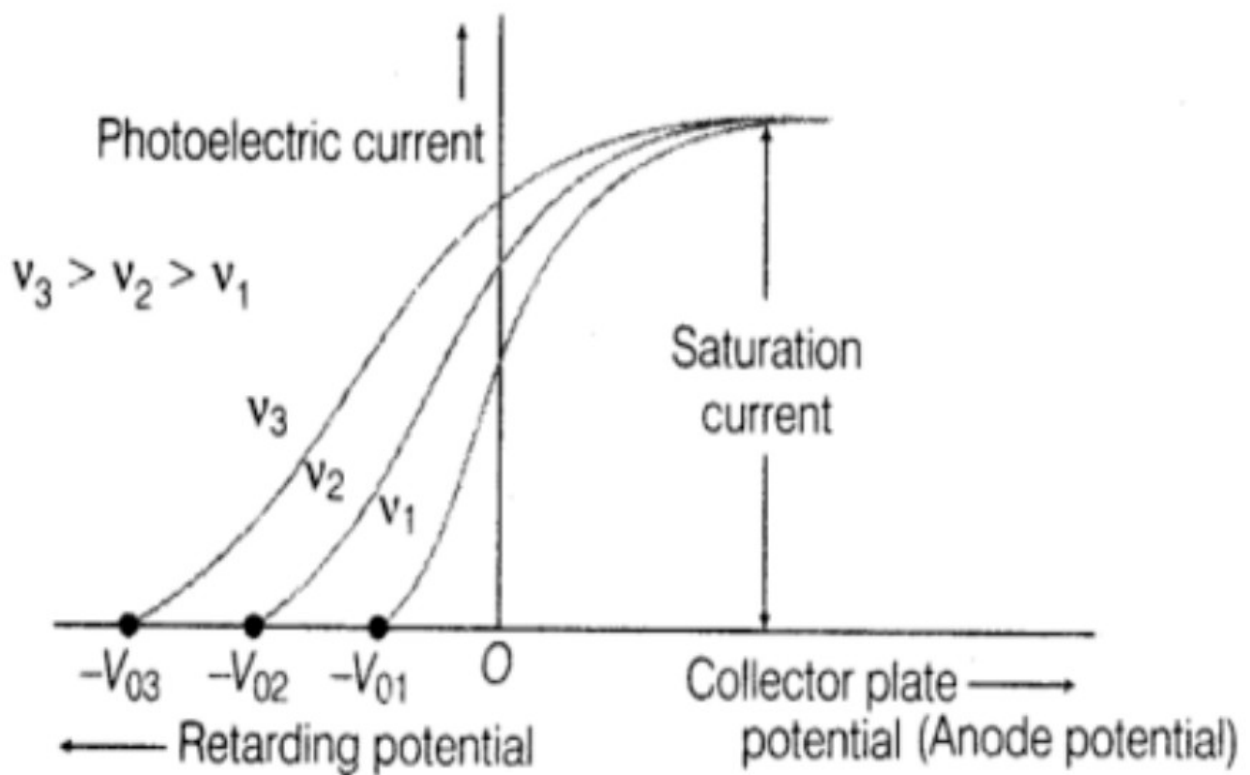

25. The plot of the binding energy per nucleon versus the mass number A for

a large number of nuclei

The nuclear force is short-ranged represents the consistency of binding energy in the range  $30 < A < 170$ .

A heavy nucleus has lower binding energy per nucleon compared to a lighter one. Suppose a nucleus with  $A = 240$  breaks into two nuclei of  $A = 120$ , nucleons get more tightly bounded. This implies that energy would be released in fission.

For two very light nuclei ( $A \leq 10$ ) joining to form a heavier nucleus. The binding energy per nucleon of heavier nucleus  $>$  binding energy per nucleon of lighter nuclei. This implies that energy is released during fusion.

26. Total energy of the electron in hydrogen atom is  $-13.6 \text{ eV} = -13.6 \times 1.6 \times 10^{-19} \text{ J} = -2.2 \times 10^{-18} \text{ J}$ .

Thus from Eq., we have

$$-\frac{e^2}{8\pi\epsilon_0 r} = E$$

This gives the orbital radius

$$r = -\frac{e^2}{8\pi\epsilon_0 E} = -\frac{(9 \times 10^9 \text{ Nm}^2/\text{C}^2)(1.6 \times 10^{-19} \text{ C})^2}{(2)(-2.2 \times 10^{-18} \text{ J})}$$

$$= 5.3 \times 10^{-11} \text{ m}$$

The velocity of the revolving electron can be computed from Eq. with  $m = 9.1 \times 10^{-31} \text{ kg}$ ,

$$\frac{1}{2}mv^2 = \frac{e^2}{4\pi\epsilon_0 r^2} \text{ thus velocity of electron is given by :-}$$

$$v = \frac{e}{\sqrt{4\pi\epsilon_0 m r^2}} = 2.2 \times 10^6 \text{ m/s}$$

27. The diagram, given here, shows several fringes, due to double-slit interference, 'contained' in a broad diffraction peak. When the separation between the slits is large compared to their width, the diffraction pattern becomes very flat and we observe the two-slit interference pattern.

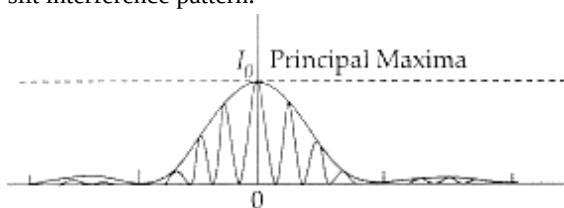

Basic features that distinguish the interference pattern from those seen in a coherently illuminated single slit.:

- i. The interference pattern has a number of equally spaced bright and dark bands while the diffraction pattern has a central bright maxima which is twice as wide as the other maxima.
- ii. Interference pattern is the superposition of two waves originating from two narrow slits. The diffraction pattern is a superposition of a continuous family of waves originating from each point on a single slit.
- iii. For a single slit of width 'a' the first null of diffraction pattern occurs at an angle of  $\frac{\lambda}{a}$ . At the same angle of  $\frac{\lambda}{a}$ , we get a maximum for two narrow slits separated by a distance a.

28. Given,

Length of loop,  $l = 8 \text{ cm} = 8 \times 10^{-2} \text{ m}$

Breadth of loop,  $b = 2 \text{ cm} = 2 \times 10^{-2} \text{ m}$

Strength of magnetic field,  $B = 0.3 \text{ T}$

Velocity of loop,  $v = 1 \text{ cm / sec} = 10^{-2} \text{ m/sec}$

Let the field be perpendicular to the plane of the paper directed inwards.

i. The magnitude of induced emf,

$$\begin{aligned} \varepsilon &= Blv \\ &= 0.3 \times 8 \times 10^{-2} \times 10^{-2} \\ &= 2.4 \times 10^{-4} \text{ V} \end{aligned}$$

Time for which induced emf will last is equal to the time taken by the coil to move outside the field is

$$t = \frac{\text{distance travelled}}{\text{velocity}} = \frac{2 \times 10^{-2}}{10^{-2}} = 2 \text{ sec}$$

ii. The conductor is moving outside the field normal to the shorter side.

$$b = 2 \times 10^{-2} \text{ m}$$

The magnitude of induced emf is

$$\begin{aligned} \varepsilon &= Bbv \\ &= 0.3 \times 2 \times 10^{-2} \times 10^{-2} \\ &= 0.6 \times 10^{-4} \text{ V} \end{aligned}$$

$$\text{Time, } t = \frac{\text{distance travelled}}{\text{velocity}} = \frac{8 \times 10^{-2}}{10^{-2}} = 8 \text{ sec}$$

OR

i. As  $\phi \propto I$ , so the graph of  $\phi$  versus  $I$  is a straight line as shown in the figure.

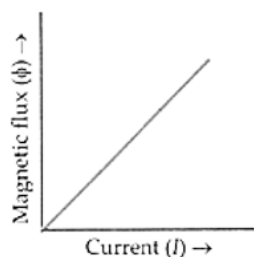

ii. As  $\varepsilon = -L \frac{dI}{dt}$ , the graph of  $\varepsilon$  versus  $\frac{dI}{dt}$  is a straight line with  $\varepsilon$  on the -ve side.

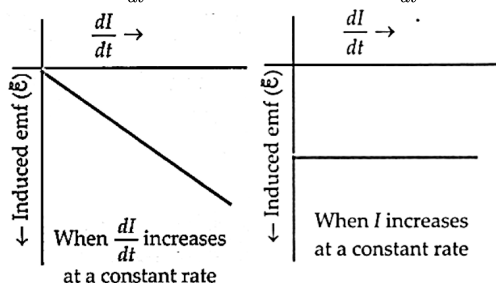

iii. Magnetic energy stored,

$$U = \frac{1}{2}LI^2$$

$$\Rightarrow U \propto I^2$$

So the graph of U versus I is a parabola as shown in

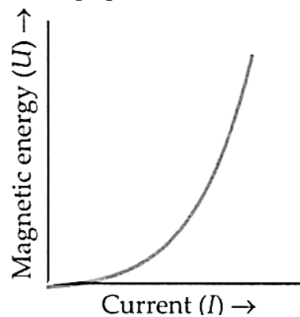

### Section D

#### 29. Read the text carefully and answer the questions:

Maxwell showed that the speed of an electromagnetic wave depends on the permeability and permittivity of the medium through which it travels. The speed of an electromagnetic wave in free space is given by  $c = \frac{1}{\sqrt{\mu_0 \epsilon_0}}$ . The fact led Maxwell to predict that light is an electromagnetic wave. The emergence of the speed of light from purely electromagnetic considerations is the crowning achievement of Maxwell's electromagnetic theory. The speed of an electromagnetic wave in any medium of permeability  $\mu$  and permittivity  $\epsilon$  will be  $\frac{c}{\sqrt{K\mu_r}}$  where K is the dielectric constant of the medium and  $\mu_r$  is the relative permeability.

(i) (b)  $ML^{-1}T^{-2}$

**Explanation:**  $\frac{1}{2}\epsilon_0 E^2 = \text{energy density} = \frac{\text{Energy}}{\text{Volume}}$

$$\therefore \left[ \frac{1}{2}\epsilon_0 E^2 \right] = \frac{ML^2 T^{-2}}{L^3} = [ML^{-1}T^{-2}]$$

(ii) (c)  $[\epsilon_0] = M^{-1}L^{-3}T^4A^2$

**Explanation:** As  $\epsilon_0 = \frac{q_1 q_2}{4\pi F R^2}$  (from Coulomb's law)

$$\epsilon_0 = \frac{C^2}{Nm^2} \frac{[AT]^2}{MLT^{-2}L^2} = M^{-1}L^{-3}T^4A^2$$

(iii) (a) wavelength is halved and the frequency remains unchanged.

**Explanation:** The frequency of the electromagnetic wave remains same when it passes from one medium to another.

$$\text{Refractive index of the medium, } n = \sqrt{\frac{\epsilon}{\epsilon_0}} = \sqrt{\frac{4}{1}} = 2$$

Wavelength of the electromagnetic wave in the medium,

$$\lambda_{\text{med}} = \frac{\lambda}{n} = \frac{\lambda}{2}$$

OR

(c) the speed of light  $c = 3 \times 10^8 \text{ m s}^{-1}$  in free space

**Explanation:** The velocity of electromagnetic waves in free space (vacuum) is equal to velocity of light in vacuum (i.e.,  $3 \times 10^8 \text{ m s}^{-1}$ ).

(iv) (a)  $\beta$ -rays

**Explanation:**  $\beta$ -rays consists of electrons which are not electromagnetic in nature.

#### 30. Read the text carefully and answer the questions:

A charge is a property associated with the matter due to which it experiences and produces an electric and magnetic field. Charges are scalar in nature and they add up like real numbers. Also, the total charge of an isolated system is always conserved. When the objects rub against each other charges acquired by them must be equal and opposite.

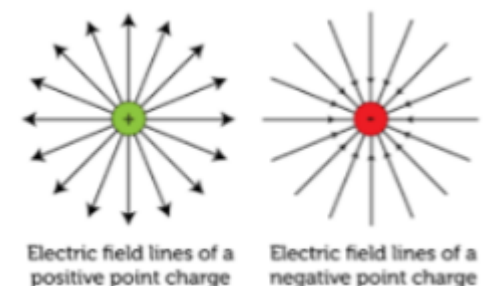



(i) (c) the actual transfer of electrons  
**Explanation:** the actual transfer of electrons

(ii) (d) Option (ii)  
**Explanation:** The glass rod gives electrons to silk when they are rubbed against each other.

(iii) (a)  $1.97 \times 10^{-8} \text{ N}$   
**Explanation:**  $1.97 \times 10^{-8} \text{ N}$

(iv) (c) both electric and magnetic effects  
**Explanation:** both electric and magnetic effects

OR

(a) transfer of an integral number of electrons  
**Explanation:** transfer of an integral number of electrons

### Section E

31. a. The figure below shows the passage of light through a triangular prism ABC.

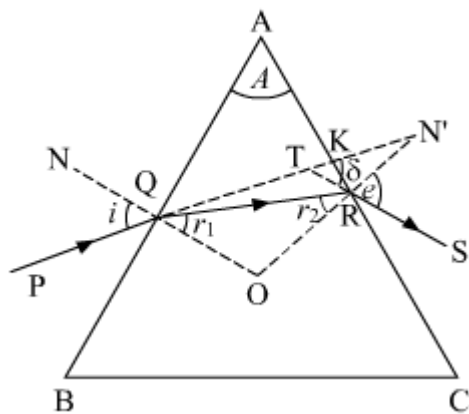

The angles of incidence and refraction at first face AB are  $\angle i$  and  $\angle r_1$

The angles of incidence at the second face AC is  $\angle r_2$  and the angle of emergence  $\angle e$

$\delta$  is the angle between the emergent ray RS and incident ray PQ and is called the angle of deviation.

Here,  $\angle PQN = i$ ,  $\angle SRN' = e$ ,  $\angle RQO = r_1$ ,  $\angle QRO = r_2$ ,  $\angle KTS = \delta$

$\therefore \angle TQO = i$  and  $\angle RQO = r_1$ , we have

$$\angle TQR = i - r_1$$

$$\angle TRO = e \text{ and } \angle QRO = r_2$$

$$\angle TRQ = e - r_2$$

In triangle TQR, the side QT has been produced outwards. Therefore, the exterior angle  $\delta$  should be equal to the sum of the interior opposite angles.

$$\text{i.e., } \delta = \angle TQR + \angle TRQ = (i - r_1) + (e - r_2)$$

$$\delta = (i + e) - (r_1 + r_2) \dots (i)$$

In triangle QRO,

$$r_1 + r_2 + \angle ROQ = 180^\circ \dots (ii)$$

From quadrilateral AROQ, we have the sum of angles ( $\angle AQO + \angle ARO = 180^\circ$ ) This means that the sum of the remaining two angles should be  $180^\circ$ .

$$\text{i.e., } \angle A + \angle QOR = 180^\circ [\angle A \text{ is called the angle of prism}]$$

From equations (i) and (ii),

$$r_1 + r_2 = A \dots (iii)$$

Substituting (iii) in (i), we obtain,

$$\delta = (i + e) - A$$

$$A + \delta = i + e$$

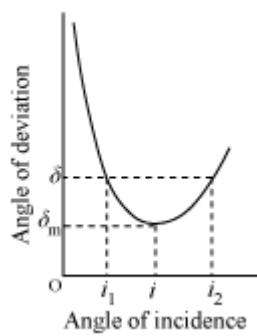

If the angle of incidence is increased gradually, then the angle of deviation first decreases, attains a minimum value ( $\delta_m$ ), and then again starts increasing.

When angle of deviation is minimum, the prism is said to be placed in the minimum deviation position.

There is only one angle of incidence for which the angle of deviation is minimum.

When

$$\delta = \delta_m \text{ [prism in minimum deviation position],}$$

$$e = i \text{ and } r_2 = r_1 = r \dots(\text{iv})$$

$$\therefore r_1 + r_2 = A$$

From equation (iv),  $r + r = A$

$$r = \frac{A}{2}$$

Also, we have

$$A + \delta = i + e$$

Setting,

$$\delta = \delta_m \text{ and } e = i$$

$$A + \delta_m = i + i$$

$$i = \frac{(A + \delta_m)}{2}$$

$$\therefore \mu = \frac{\sin i}{\sin r}$$

$$\therefore \mu = \frac{\sin\left(\frac{A + \delta_m}{2}\right)}{\sin\left(\frac{A}{2}\right)}$$

- b. The incident ray travelling from denser medium to rarer medium grazes along the surface of the separation of the medium only when the light ray incident at the surface at an angle called critical angle (C) such that the angle of reflection is  $90^\circ$ .

Therefore, following Snell's law, we can write

$$\frac{\mu_1}{\mu_2} = \frac{\sin 90}{\sin C}$$

$$\frac{\mu_1}{\mu_2} = \frac{1}{\sin C}$$

$$\frac{\sqrt{2}}{1} = \frac{1}{\sin C}$$

$$\sin C = \frac{1}{\sqrt{2}}$$

$$C = \sin^{-1}\left(\frac{1}{\sqrt{2}}\right)$$

$$\therefore \text{Critical angle} = \text{Angle of incidence} = 45^\circ$$

OR

Angular width is given by

$$\theta = \frac{\lambda}{d} \text{ or } d = \frac{\lambda}{\theta}$$

- i. According to the question,  $\lambda = 600 \text{ nm} = 6 \times 10^{-7} \text{ m}$

$$\theta = \frac{0.1\pi}{180} \text{ rad} = \frac{\pi}{1800} \text{ rad}$$

$$d = \frac{\lambda}{\theta}$$

$$\therefore d = \frac{6 \times 10^{-7} \times 1800}{\pi} = 3.44 \times 10^{-4} \text{ m}$$

- ii. The frequency of a light depends on its source only.

So, the frequencies of reflected and refracted light will be same as that of incident light.

Reflected light is in the same medium (air).

So its wavelength remains same as  $500 \overset{\circ}{\text{A}}$ .

We know that  $\nu = \frac{c}{\lambda}$

$$= \frac{3 \times 10^8}{5000 \times 10^{-10}}$$

$$= 6 \times 10^{18} \text{ Hz}$$

This is the required frequency of both refracted and reflected light.

We know that,

$$\mu = \frac{\text{speed of light in air}}{\text{speed of light in water}}$$

$$\frac{4}{3} = \frac{3 \times 10^8}{v}$$

$$v = 2.25 \times 10^8 \text{ m/s}$$

$$\text{speed of light in water} = 2.25 \times 10^8 \text{ m/s}$$

$$\text{Wavelength of refracted light is given by } \lambda' = \frac{v}{\nu} = 0.375 \times 10^{-6} \text{ m}$$

So, wavelength of refracted wave will be decreased.

32. i. On introduction of dielectric slab of dielectric constant K in an isolated charged capacitor.

a. The capacitance (C') becomes K times of original capacitor as

$$C = \frac{\epsilon_0 A}{d} \text{ and } C' = \frac{K\epsilon_0 A}{d}$$

(where A and d being cross-sectional area of each plate and distance of separation of the plates respectively)

b. Charge remains conserved in this phenomenon.

$$CV = C'V'$$

$$\Rightarrow V' = \frac{CV}{C'} = \frac{CV}{KC}$$

$$\Rightarrow V' = \frac{V}{K}$$

Potential difference decreases and becomes  $\frac{1}{K}$  times of its previous original value.

c. Energy stored initially in the capacitor,

$$U = \frac{q^2}{2C}$$

Energy stored in the capacitor after inserting the dielectric,

$$\therefore U' = \frac{q^2}{2KC} [\because C' = KC]$$

where, K = dielectric constant of medium

$$\Rightarrow U' = \frac{1}{K} \left( \frac{q^2}{2C} \right) \Rightarrow U' = \frac{1}{K} (U) \Rightarrow U' = \frac{1}{K} \times U$$

The energy stored in the capacitor decreases and becomes  $\frac{1}{K}$  times of original energy

ii. a. Electric field lines due to a conducting sphere are shown in the figure:

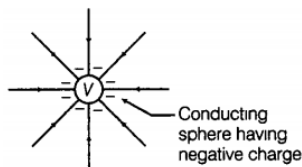

b. Electric field lines due to an electric dipole are shown in the figure:

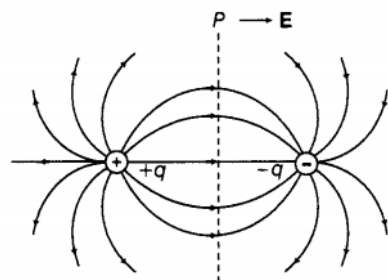

OR

Capacitors  $C_2$  and  $C_3$  form a parallel combination of equivalent capacitance,

$$C_8 = C_2 + C_3 = 2 + 2 = 4 \mu\text{F}$$

Capacitors  $C_4$  and  $C_5$  form a series combination of capacitance  $C_9$  given by

$$\frac{1}{C_9} = \frac{1}{C_4} + \frac{1}{C_5} = \frac{1}{12} + \frac{1}{6} = \frac{3}{12} = \frac{1}{4}$$

$$\therefore C_9 = 4 \mu\text{F}$$

The equivalent circuit can be shown as in Fig.

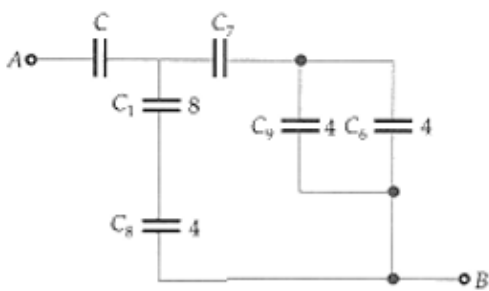

Capacitors  $C_1$  and  $C_8$  form a series combination of capacitance  $C_{10}$  given by

$$C_{10} = \frac{C_1 C_8}{C_1 + C_8} = \frac{8 \times 4}{8 + 4} = \frac{32}{12} = \frac{8}{3} \mu\text{F}$$

Capacitors  $C_6$  and  $C_9$  form a parallel combination of capacitance.

$$C_{11} = C_6 + C_9 = 4 + 4 = 8 \mu\text{F}$$

The given network reduces to the equivalent circuit

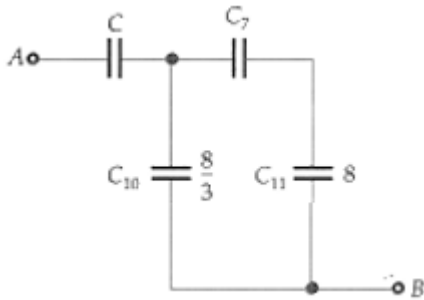

Again, capacitors  $C_7$  and  $C_{11}$  form a series combination of capacitance  $C_{12}$  given by

$$C_{12} = \frac{C_7 \times C_{11}}{C_7 + C_{11}} = \frac{1 \times 8}{1 + 8} = \frac{8}{9} \mu\text{F}$$

Now  $C_{10}$  and  $C_{12}$  form a parallel combination of capacitance  $C_{13}$  as shown in Fig.

$$C_{13} = C_{10} + C_{12} = \frac{8}{3} + \frac{8}{9} = \frac{32}{9} \mu\text{F}$$

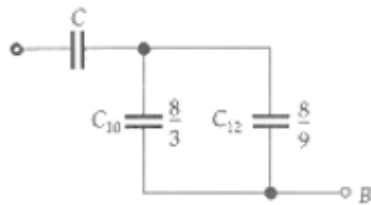

Finally, the capacitors  $C$  and  $C_{13}$  form a series combination of capacitance  $1 \mu\text{F}$  as shown in Fig.

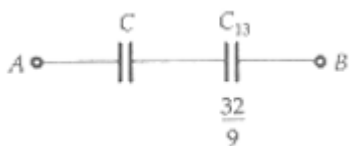

$$\frac{1}{1} = \frac{1}{C} + \frac{9}{32} \text{ or } C = \frac{32}{23} \mu\text{F}$$

33. i. If an alternating voltage  $V = V_0 \sin \omega t$  is applied across pure inductor of inductance  $L$ , then the magnitude of induced emf will

be equal to the applied voltage,

$$E = L \frac{dI}{dt}$$

For the circuit, the magnitude of induced emf = applied voltage

$$L \frac{dI}{dt} = V_0 \sin \omega t$$

$$dI = \frac{V_0}{L} \sin \omega t dt$$

Integrating both the sides, we get

$$I = \frac{V_0}{L} \int \sin \omega t dt = \frac{V_0}{L} \left( \frac{-\cos \omega t}{\omega} \right)$$

$$I = -\frac{V_0}{\omega L} \cos \omega t = -\frac{V_0}{\omega L} \sin \left( \frac{\pi}{2} - \omega t \right) \sin(-\theta) = -\theta \text{ hence the equation is modified to}$$

$$I = \frac{V_0}{X_L} \sin \left( \omega t - \frac{\pi}{2} \right)$$

thus the current in the circuit,  $I = I_0 \sin \left( \omega t - \frac{\pi}{2} \right)$  this is the required expression.

ii. The average power supplied by the source over a complete cycle is

$$P_{av} = E_{rms} I_{rms} \cos \phi$$

When the circuit carries an ideal inductor, then the phase difference between the current and voltage is  $\frac{\pi}{2}$

In case of the pure inductive circuit,

$$\phi = \frac{\pi}{2}$$

$$\text{But } \cos \frac{\pi}{2} = 0$$

So power dissipated = 0

Hence, when an ac source is connected to an ideal inductor, the average power supplied by the source over a complete cycle is zero.

OR

i.

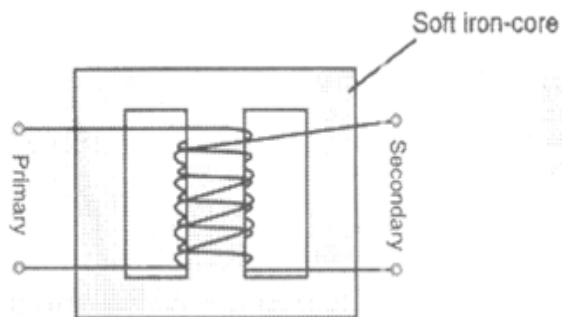

Working principle:

Step-down transformer is made up of two or more coil wound on the iron core of the transformer. It works on the principle of magnetic induction between the coils. Whenever current in one coil changes an emf gets induced in the neighboring coil (Principle of mutual induction)

Voltage across secondary

$$V_s = e_s = -N_s \frac{d\phi}{dt}$$

Voltage across primary

$$V_p = e_p = -N_p \frac{d\phi}{dt}$$

$$\frac{V_s}{V_p} = \frac{N_s}{N_p} \text{ (here, } N_s > N_p \text{)}$$

In an ideal transformer

Power Input = Power output

$$I_p V_p = I_s V_s$$

$$\therefore \frac{V_s}{V_p} = \frac{N_s}{N_p} = \frac{I_p}{I_s}$$

ii.

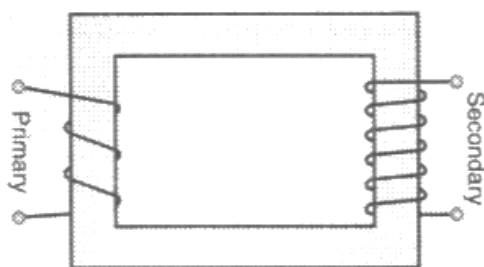

$$\text{Input power, } P_i = I_i \times V_i = 15 \times 100 = 1500 \text{ W}$$

$$\text{Power output, } P_o = P_i \times \frac{90}{100} = 1350 \text{ W}$$

$$\Rightarrow I_o V = 1350 \text{ W}$$

$$\text{Output voltage, } V_o = \frac{1350}{3} \text{ V} = 450 \text{ V}$$